

## 3-A, 3.3/5-V INPUT ADJUSTABLE SWITCHING REGULATOR

### FEATURES

- Up to 3-A Output Current at 85°C
- 3.3-V / 5-V Input Voltage
- Wide-Output Voltage Adjust (0.9 V to 3.6 V)
- 160 W/in<sup>3</sup> Power Density
- Efficiencies Up To 94%
- On/Off Inhibit
- Undervoltage Lockout (UVLO)
- Output Overcurrent Protection (Nonlatching, Auto-Reset)
- Overtemperature Protection
- Ambient Temp. Range: -40°C to 85°C

- Surface Mount Package
- Safety Agency Approvals: UL/IEC/CSA-C22.2 60950-1

### APPLICATIONS

- Telecommunications, Instrumentation, and General-Purpose Circuits

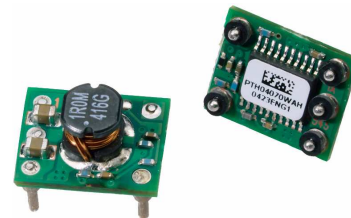

### DESCRIPTION

The PTH04070W is a highly integrated, low-cost switching regulator module that delivers up to 3 A of output current. Occupying less PCB area than a standard TO-220 linear regulator IC, the PTH04070W provides output current at a much higher efficiency and with much less power dissipation, thereby eliminating the need for a heat sink. Their small size (0.5 × 0.4 in), high efficiency, and low cost makes these modules attractive for a variety of applications.

The input voltage range of the PTH04070W is from 3 V to 5.5 V, allowing operation from either a 3.3-V or 5-V input bus. Using state-of-the-art switched-mode power-conversion technology, the PTH04070W can step down to voltages as low as 0.9 V from a 5-V input bus, with typically less than 1 W of power dissipation. The output voltage can be adjusted to any voltage over the range, 0.9 V to 3.6 V, using a single external resistor. Operating features include an undervoltage lockout (UVLO), on/off inhibit, output overcurrent protection, and overtemperature protection. Target applications include telecommunications, test and measurement applications, and high-end consumer products. The modules are available in both through-hole and surface-mount package options, including tape and reel.

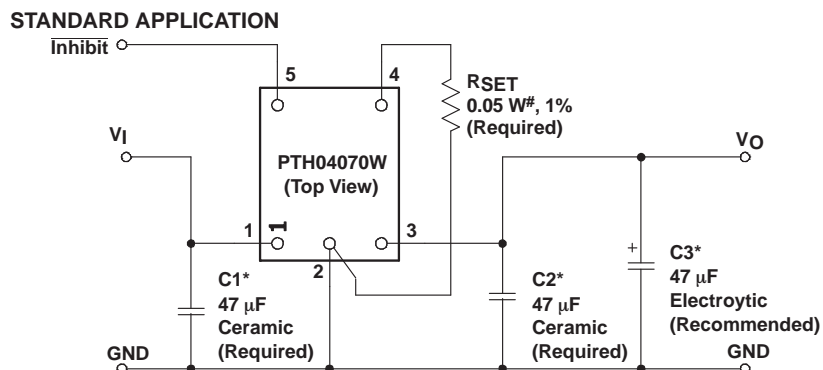

#See The Specification Table for Value

\*See The Capacitor Application Information



Please be aware that an important notice concerning availability, standard warranty, and use in critical applications of Texas Instruments semiconductor products and disclaimers thereto appears at the end of this data sheet.



These devices have limited built-in ESD protection. The leads should be shorted together or the device placed in conductive foam during storage or handling to prevent electrostatic damage to the MOS gates.

**ORDERING INFORMATION**

For the most current package and ordering information, see the Package Option Addendum at the end of this datasheet, or see the TI website at [www.ti.com](http://www.ti.com).

**ABSOLUTE MAXIMUM RATINGS**

over operating free-air temperature range unless otherwise noted<sup>(1)</sup>

			PTH04070	UNIT	
T <sub>A</sub>	Operating free-air temperature	Over V <sub>I</sub> range	-40 to 85	°C	
T <sub>wave</sub>	Wave solder temperature	Surface temperature of module body or pins (5 seconds maximum)	260		
T <sub>reflow</sub>	Solder reflow temperature	Surface temperature of module body or pins	Suffix AS		235 <sup>(2)</sup>
			Suffix AZ		260 <sup>(2)</sup>
T <sub>stg</sub>	Storage temperature		-55 to 125 <sup>(3)</sup>		

- (1) Stresses beyond those listed under absolute maximum ratings may cause permanent damage to the device. These are stress ratings only, and functional operation of the device at these or any other conditions beyond those indicated under recommended operating conditions is not implied. Exposure to absolute-maximum-rated conditions for extended periods may affect device reliability.
- (2) During reflow of surface mount package version do not elevate peak temperature of the module, pins or internal components above the stated maximum.
- (3) The shipping tray or tape and reel cannot be used to bake parts at temperatures higher than 65°C.

**RECOMMENDED OPERATING CONDITIONS**

		MIN	MAX	UNIT
V <sub>I</sub>	Input voltage	3	5.5	V
T <sub>A</sub>	Operating free-air temperature	-40	85	°C

**PACKAGE SPECIFICATIONS**

PTH04070WXX		
Weight		1.5 grams
Flammability	Meets UL 94 V-O	
Mechanical shock	Per Mil-STD-883D, Method 2002.3, 1 msec, 1/2 sine, mounted	500 G <sup>(1)</sup>
Mechanical vibration	Mil-STD-883D, Method 2007.2, 20-2000 Hz	20 G <sup>(1)</sup>

- (1) Qualification limit.

## ELECTRICAL CHARACTERISTICS

 at 25°C free-air temperature,  $V_I = 5\text{ V}$ ,  $V_O = 3.3\text{ V}$ ,  $I_O = I_O(\text{Max})$ ,  $C1 = 47\text{ }\mu\text{F}$ ,  $C2 = 47\text{ }\mu\text{F}$  (unless otherwise noted)

PARAMETER		TEST CONDITIONS	MIN	TYP	MAX	UNIT
$I_O$	Output current	$T_A = 85^\circ\text{C}$ , natural convection airflow	0		3	A
$V_I$	Input voltage range	Over $I_O$ range	3		5.5	V
$V_{O(\text{tol})}$	Set-point voltage tolerance	$T_A = 25^\circ\text{C}$			$\pm 2$ <sup>(1)</sup>	% $V_O$
	Temperature variation	$-40 \leq T_A \leq +85^\circ\text{C}$		$\pm 0.5$		% $V_O$
	Line regulation	Over $V_I$ range		$\pm 1$		mV
	Load regulation	Over $I_O$ range		$\pm 5$		mV
	Total output voltage variation	Includes set-point, line, load, $-40 \leq T_A \leq +85^\circ\text{C}$			$\pm 3$ <sup>(1)</sup>	% $V_O$
$V_{O(\text{adj})}$	Output voltage adjust range	$V_I \geq 4.5\text{ V}$ $V_I < 4.5\text{ V}$	0.9 0.9		3.6 $V_I - 1.1$ <sup>(2)</sup>	V
$\eta$	Efficiency	$T_A = 25^\circ\text{C}$ , $I_O = 2\text{ A}$ $R_{\text{SET}} = 475\text{ }\Omega$ , $V_O = 3.3\text{ V}$ <sup>(2)</sup> $R_{\text{SET}} = 2.32\text{ k}\Omega$ , $V_O = 2.5\text{ V}$ <sup>(2)</sup> $R_{\text{SET}} = 4.87\text{ k}\Omega$ , $V_O = 2\text{ V}$ $R_{\text{SET}} = 6.65\text{ k}\Omega$ , $V_O = 1.8\text{ V}$ $R_{\text{SET}} = 11.5\text{ k}\Omega$ , $V_O = 1.5\text{ V}$ $R_{\text{SET}} = 26.1\text{ k}\Omega$ , $V_O = 1.2\text{ V}$ $R_{\text{SET}} = 84.5\text{ k}\Omega$ , $V_O = 1\text{ V}$		92% 90% 88% 87% 85% 82% 80%		
	Output voltage ripple	20 MHz bandwidth		10		mV <sub>PP</sub>
$I_{O(\text{trip})}$	Overcurrent threshold	Reset, followed by autorecovery		7		A
	Transient response	$C3 = 47\text{ }\mu\text{F}$ , 1 A/ $\mu\text{s}$ load step from 50% to 100% $I_{O(\text{max})}$ Recovery time $V_O$ over/undershoot		70		$\mu\text{s}$
				100		mV
UVLO	Undervoltage lockout	$V_I = \text{increasing}$		2.95	3	V
		$V_I = \text{decreasing}$	2.7	2.8		
	Inhibit control (pin 5)	Input high voltage ( $V_{IH}$ )	$V_I - 0.5$		Open <sup>(3)</sup>	V
		Input low voltage ( $V_{IL}$ )	-0.2		0.6	
		Input low current ( $I_{IL}$ )		-10		
$I_{I(\text{stby})}$	Input standby current	Pin 5 connected to GND		1		mA
$F_S$	Switching frequency	Over $V_I$ and $I_O$ ranges		700		kHz
	External input capacitance	Ceramic type (C1)	47 <sup>(4)</sup>			$\mu\text{F}$
	External output capacitance	Ceramic type (C2)	47 <sup>(5)</sup>		200	$\mu\text{F}$
		Nonceramic type (C3)		47 <sup>(5)</sup>	560 <sup>(6)</sup>	
		Equivalent series resistance (nonceramic)	4 <sup>(7)</sup>			
MTBF	Calculated reliability	Per Bellcore TR-332, 50% stress, $T_A = 40^\circ\text{C}$ , ground benign	48			10 <sup>6</sup> Hrs

- The set-point voltage tolerance is affected by the tolerance and stability of  $R_{\text{SET}}$ . The stated limit is unconditionally met if  $R_{\text{SET}}$  has a tolerance of 1% with 100 ppm/ $^\circ\text{C}$  or better temperature stability.
- The minimum input voltage is 3 V or  $(V_O + 1.1)\text{ V}$ , whichever is greater. A 5-V input bus is recommended for output voltages higher than 2 V.
- This control pin has an internal pullup to the input voltage  $V_I$ . If it is left open circuit, the module operates when input power is applied. A small low-leakage (<100 nA) MOSFET is recommended for control. Do not tie the inhibit pin to  $V_I$  or to another module's inhibit pin. See the application section for further guidance.
- An external 47- $\mu\text{F}$  ceramic capacitor is required across the input ( $V_I$  and GND) for proper operation. Locate the capacitor close to the module.
- An external 47- $\mu\text{F}$  ceramic capacitor is required across the output ( $V_O$  and GND) for proper operation. Locate the capacitor close to the module. Adding another 47  $\mu\text{F}$  of electrolytic capacitance close to the load improves the response of the regulator to load transients.
- This is the calculated maximum capacitance. The minimum ESR limitation often results in a lower value. See the capacitor application information for further guidance.
- This is the typical ESR for all the electrolytic (nonceramic) capacitance. Use 7 m $\Omega$  as the minimum when calculating the total equivalent series resistance (ESR) using the max-ESR values specified by the capacitor manufacturer.

**PIN ASSIGNMENT**  
**TERMINAL FUNCTIONS**

TERMINAL		I/O	DESCRIPTION
NAME	NO.		
$V_I$	1	I	The positive input voltage power node to the module, which is referenced to common GND.
GND	2		This is the common ground connection for the $V_I$ and $V_O$ power connections. It is also the 0 VDC reference for the <i>Inhibit</i> and $V_O$ <i>Adjust</i> control inputs.
$V_O$	3	O	The regulated positive power output with respect to the GND node.
$V_O$ Adjust	4	I	A 1% resistor must be connected between this pin and GND (pin 1) to set the output voltage of the module higher than 0.9 V. If left open-circuit, the output voltage defaults to this value. The temperature stability of the resistor should be 100 ppm/°C (or better). The set-point range is from 0.9 V to 3.6 V. The electrical specification table gives the standard resistor value for a number of common output voltages. Refer to the application information for further guidance.
Inhibit	5	I	The Inhibit pin is an open-collector/drain-negative logic input that is referenced to GND. Applying a low-level ground signal to this input disables the module's output. When the Inhibit control is active, the input current drawn by the regulator is significantly reduced. If the Inhibit pin is left open-circuit, the module will produce an output voltage whenever a valid input source is applied.

**TYPICAL CHARACTERISTICS (5-V INPUT)<sup>(1)(2)</sup>**

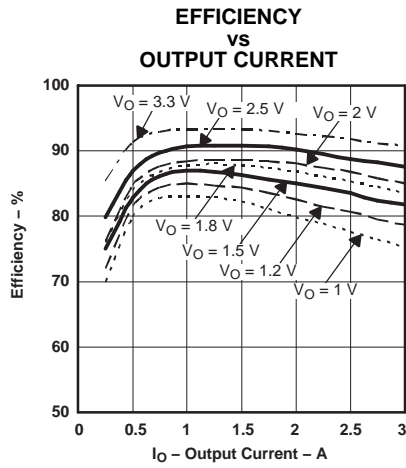

Figure 1.

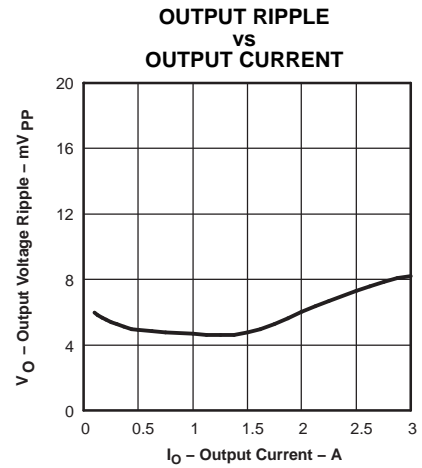

Figure 2.

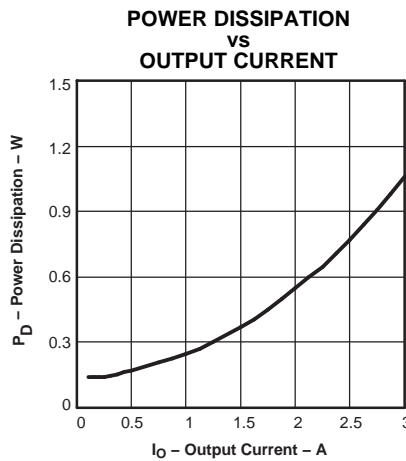

Figure 3.

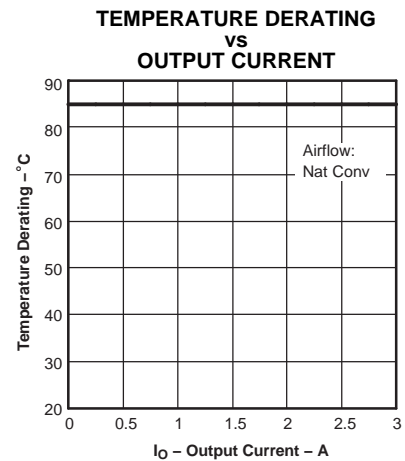

Figure 4.

- (1) The electrical characteristic data has been developed from actual products tested at 25°C. This data is considered typical for the converter. Applies to [Figure 1](#), [Figure 2](#), and [Figure 3](#).
- (2) The temperature derating curves represent the conditions at which internal components are at or below the manufacturer's maximum operating temperatures. Derating limits apply to modules soldered directly to a 100 mm × 100 mm double-sided PCB with 1 oz. copper. Applies to [Figure 4](#).

TYPICAL CHARACTERISTICS (3.3-V INPUT)<sup>(1)(2)</sup>

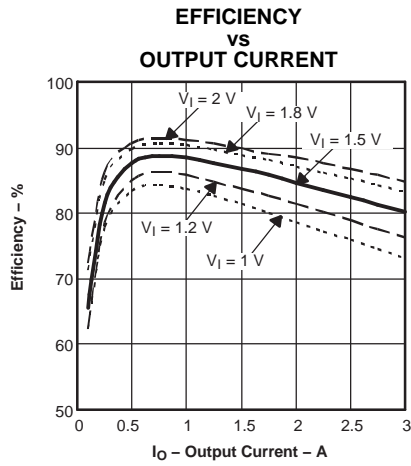

Figure 5.

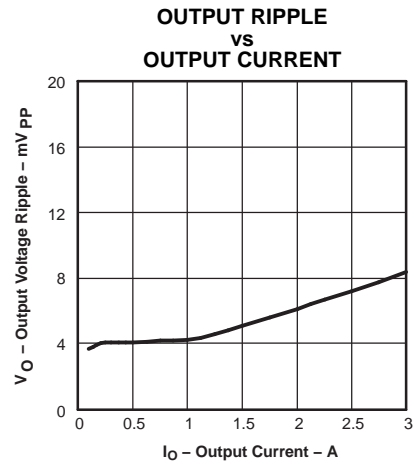

Figure 6.

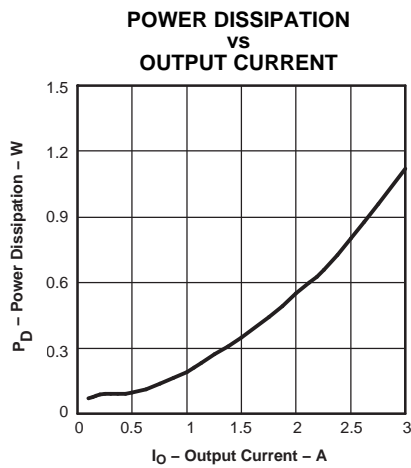

Figure 7.

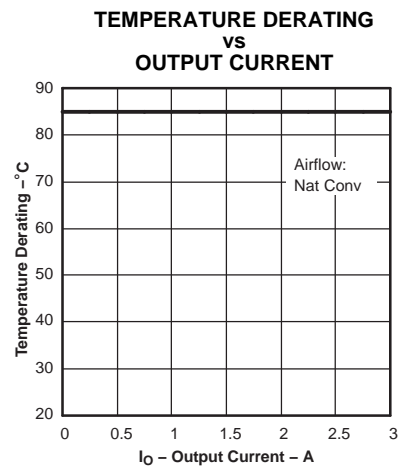

Figure 8.

- (1) The electrical characteristic data has been developed from actual products tested at 25°C. This data is considered typical for the converter. Applies to [Figure 5](#), [Figure 6](#), and [Figure 7](#).
- (2) The temperature derating curves represent the conditions at which internal components are at or below the manufacturer's maximum operating temperatures. Derating limits apply to modules soldered directly to a 100 mm × 100 mm double-sided PCB with 1 oz. copper. Applies to [Figure 8](#).

## APPLICATION INFORMATION

### Adjusting the Output Voltage of the PTH04070W Wide-Output Adjust Power Modules

The  $V_OAdjust$  control (pin 4) sets the output voltage of the PTH04070W product. The adjustment range is from 0.9 V to 3.6 V. The adjustment method requires the addition of a single external resistor,  $R_{SET}$ , that must be connected directly between the  $V_OAdjust$  and  $GND$  pin 2. Table 1 gives the standard external resistor for a number of common bus voltages, along with the actual voltage the resistance produces.

For other output voltages, the value of the required resistor can either be calculated using the following formula, or simply selected from the range of values given in Table 2. Figure 9 shows the placement of the required resistor.

$$R_{set} = 10 \text{ k}\Omega \times \frac{0.891 \text{ V}}{V_{out} - 0.9 \text{ V}} - 3.24 \text{ k}\Omega$$

**Table 1. Standard Values of  $R_{set}$  for Common Output Voltages**

$V_O$ (V) (Required)	$R_{SET}$ (k $\Omega$ ) (Standard Value)	$V_O$ (V) (Actual)
3.3 <sup>(1)</sup>	0.475	3.298
2.5 <sup>(1)</sup>	2.32	2.502
2	4.87	1.999
1.8	6.65	1.801
1.5	11.5	1.504
1.2	26.1	1.204
1	84.5	1.001
0.9	Open	0.9

(1) The minimum input voltage is 3 V or ( $V_O + 1.1$ ) V, whichever is greater.

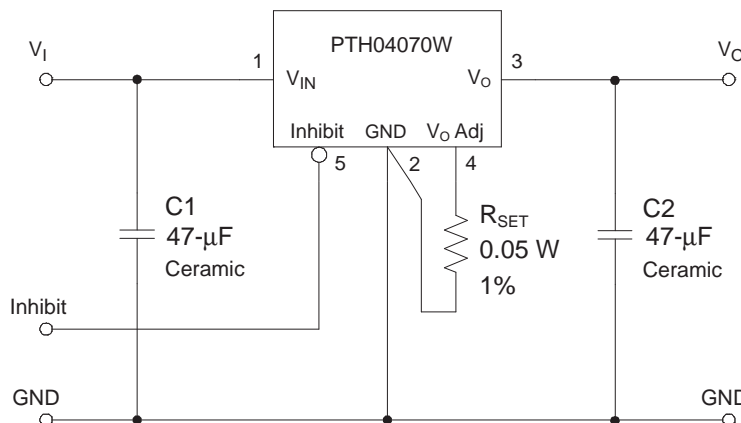

- (1) A 0.05-W rated resistor may be used. The tolerance should be 1%, with a temperature stability of 100 ppm/°C (or better). Place the resistor as close to the regulator as possible. Connect the resistor directly between pins 4 and 2 using dedicated PCB traces.
- (2) Never connect capacitors from  $V_OAdjust$  to either  $GND$  or  $V_O$ . Any capacitance added to the  $V_OAdjust$  pin will affect the stability of the regulator.

**Figure 9.  $V_O$  Adjust Resistor Placement**

**Table 2. Calculated Set-Point Resistor Values**

$V_O$ Req'd (V)	$R_{SET}$ (k $\Omega$ )	$V_O$ Req'd (V)	$R_{SET}$ (k $\Omega$ )	$V_O$ Req'd (V)	$R_{SET}$ (k $\Omega$ )
0.900	Open	1.475	12.3	2.55	2.16
0.925	353	1.50	11.6	2.60	2.00
0.950	175	1.55	10.5	2.65	1.85
0.975	116	1.60	9.49	2.70	1.71
1.000	85.9	1.65	8.64	2.75	1.58
1.025	68.0	1.70	7.90	2.80	1.45
1.050	56.2	1.75	7.24	2.85	1.33
1.075	47.7	1.80	6.66	2.90	1.22
1.100	41.3	1.85	6.14	2.95	1.11
1.125	36.4	1.90	5.67	3.00	1.00
1.150	32.4	1.95	5.25	3.05	0.904
1.175	29.2	2.00	4.86	3.10	0.810
1.200	26.5	2.05	4.51	3.15	0.720
1.225	24.2	2.10	4.19	3.20	0.634
1.250	22.2	2.15	3.89	3.25	0.551
1.275	20.5	2.20	3.61	3.30	0.473
1.300	19.0	2.25	3.36	3.35	0.397
1.325	17.7	2.30	3.12	3.40	0.324
1.350	16.6	2.35	2.90	3.45	0.254
1.375	15.5	2.40	2.70	3.50	0.187
1.400	14.6	2.45	2.51	3.55	0.122
1.425	13.7	2.50	2.33	3.60	0.060
1.450	13.0				



## **CAPACITOR RECOMMENDATIONS for the PTH04070W WIDE-OUTPUT ADJUST POWER MODULES**

### **Input Capacitor**

The minimum recommended input capacitor(s) is 47- $\mu$ F of ceramic capacitance, in either an X5R or X7R temperature tolerance. The ceramic capacitors should be located within 0.5 in. (1.27 cm) of the regulator's input pins. Electrolytic capacitors can also be used at the input, but only in addition to the required ceramic capacitance. The minimum ripple current rating for nonceramic capacitors should be at least 200 mA rms. The ripple current rating of electrolytic capacitors is a major consideration when they are used at the input.

When specifying regular tantalum capacitors for use at the input, a minimum voltage rating of  $2 \times$  (maximum dc voltage + ac ripple) is highly recommended. This is standard practice to ensure reliability. Polymer-tantalum capacitors are not affected by this requirement.

For improved ripple reduction on the input bus, additional ceramic capacitors can be used to complement the minimum requirement.

### **Output Capacitors**

For most applications only one (1) 47- $\mu$ F ceramic capacitor is required. The ceramic capacitor should be located within 0.5 in. (1.27 cm) of the output pin. Adding a second 47- $\mu$ F nonceramic capacitor allows the module to meet its transient response specification. For applications with load transients (sudden changes in load current), the regulator response benefits from additional external output capacitance. A high-quality computer-grade electrolytic capacitor should be adequate.

Electrolytic capacitors should be located close to the load circuit. These capacitors provide decoupling over the frequency range, 2 kHz to 150 kHz. Aluminum electrolytic capacitors are suitable for ambient temperatures above 0°C. For operation below 0°C, tantalum or OS-CON type capacitors are recommended. When using one or more nonceramic capacitors, the calculated equivalent ESR should be no lower than 4 m $\Omega$  (7 m $\Omega$  using the manufacturer's maximum ESR for a single capacitor). A list of preferred low-ESR type capacitors are identified in [Table 3](#), the recommended capacitor table.

### **Ceramic Capacitors**

Above 150 kHz the performance of aluminum electrolytic capacitors becomes less effective. To further improve the reflected input ripple current, or the output transient response, multilayer ceramic capacitors must be added. Ceramic capacitors have very low ESR and their resonant frequency is higher than the bandwidth of the regulator. When placed at the output their combined ESR is not critical as long as the total value of ceramic capacitance does not exceed 200  $\mu$ F. Also, to prevent the formation of local resonances, do not place more than three identical ceramic capacitors with values of 10  $\mu$ F or greater in parallel.

### **Tantalum Capacitors**

Additional tantalum type capacitors can be used at both the input and output, and are recommended for applications where the ambient operating temperature can be less than 0°C. The AVX TPS, Sprague 593D/594/595 and Kemet T495/T510/T520 capacitors series are suggested over many other tantalum types due to their rated surge, power dissipation, and ripple current capability. As a caution, many general-purpose tantalum capacitors have considerably higher ESR, reduced power dissipation, and lower ripple current capability. These capacitors are also less reliable as they have lower power dissipation and surge current ratings. Tantalum capacitors that do not have a stated ESR or surge current rating are not recommended for power applications. When specifying OS-CON and polymer tantalum capacitors for the output, the minimum ESR limit is encountered well before the maximum capacitance value is reached.

### **Capacitor Table**

The capacitor table, [Table 3](#), identifies the characteristics of capacitors from a number of vendors with acceptable ESR and ripple current (rms) ratings. The recommended number of capacitors required at both the input and output buses is identified for each capacitor type. This is not an extensive capacitor list. Capacitors from other vendors are available with comparable specifications. Those listed are for guidance. The rms rating and ESR (at 100 kHz) are critical parameters necessary to insure both optimum regulator performance and long capacitor life.

## Designing for Load Transients

The transient response of the dc/dc converter has been characterized using a load transient with a di/dt of 1 A/μs. The typical voltage deviation for this load transient is given in the data sheet specification table using the optional value of output capacitance. As the di/dt of a transient is increased, the response of a converter's regulation circuit ultimately depends on its output capacitor decoupling network. This is an inherent limitation with any dc/dc converter once the speed of the transient exceeds its bandwidth capability. If the target application specifies a higher di/dt or lower voltage deviation, the requirement can only be met with additional output capacitor decoupling. In these cases, special attention must be paid to the type, value, and ESR of the capacitors selected.

If the transient performance requirements exceed those specified in the data sheet, the selection of output capacitors becomes more important. Review the minimum ESR in the characteristic data sheet for details on the capacitance maximum.

**Table 3. Recommended Input/Output Capacitors**

CAPACITOR VENDOR/ COMPONENT SERIES	CAPACITOR CHARACTERISTICS					QUANTITY		VENDOR NUMBER
	WORKING VOLTAGE (V)	VALUE (μF)	EQUIVALENT SERIES RESISTANCE (ESR) (Ω)	85°C MAXIMUM RIPPLE CURRENT (I <sub>rms</sub> ) (mA)	PHYSICAL SIZE (mm)	INPUT BUS <sup>(1)</sup>	OUTPUT BUS	
Panasonic WA (SMT) FC (SMT)	10 25	120 47	0.035 0.400	2800 230	8×6.9 8×6.2	1 1	≤ 4 <sup>(1)</sup> 1 <sup>(1)</sup>	EEFWA1A121P <sup>(2)</sup> EEVFC1E470P <sup>(2)</sup>
Panasonic SL SP-cap(SMT)	6.3 6.3	47 56	0.018 0.009	2500 3000	7.3×4.3 7.3×4.3	1 1	≤ 3 ≤ 2	EEFCD0J470R EEFSL0J560R
United Chemi-con PXA (SMT) FS LXZ MVZ (SMT)	10 10 16 16	47 100 100 100	0.031 0.040 0.250 0.440	2250 2100 290 230	6.3×5.7 6.3×9.8 6.3×11.5 6.3×5.7	1 1 1 1	1 ≤ 5 1 1	PXA10VC470MF60TP 10FS100M LXZ16VB101M6X11LL MVZ16VC101MF60TP
Nichicon UWG (SMT) F559(Tantalum) PM	16 10 10	100 100 100	0.400 0.055 0.550	230 2000 210	8×6.2 7.7×4.3 6×11	1 1 1	1 ≤ 5 1	UWG1C101MCR1GS F551A107MN UPM1A101MEH
Sanyo Os-con\ POS-Cap SVP (SMT) SP	10 6.3 10	68 47 56	0.025 0.074 0.045	2400 1110 1710	7.3×4.3 5×6 6.3×5.0	1 1 1	≤ 5 ≤ 5 ≤ 5	10TPE68M 6SVP47M 10SP56M
AVX Tantalum TPS (SMD)	10 10	47 47	0.10 0.060	1100 > 412	7.3L×4.3W ×4.1H	1 1	≤ 5 ≤ 5	TPSD476M010R0100 TPSB476M010R0500
Kemet T520 (SMD) AO-CAP	10 6.3	68 47	0.060 0.028	>1200 >1100	7.3L×5.7W ×4.0H	1 1	≤ 5 ≤ 3	T520V686M010ASE060 A700V476M006AT
Vishay/Sprague 594D/595D (SMD)	10 10	68 68	0.100 0.240	>1000 680	7.3L×6.0W ×4.1H	1 1	≤ 5 ≤ 5	594D686X0010C2T 595D686X0010C2T
94SL	16	47	0.070	1550	8×5	1	≤ 5	94SL476X0016EBP
TDK Ceramic X5R Murata Ceramic X5R Kemet	6.3 6.3 6.3	22 22 22	0.002 0.002 0.002	>1400 >1000 >1000	1210 case 3225 mm	≥ 2 <sup>(3)</sup> ≥ 2 <sup>(3)</sup> ≥ 2 <sup>(3)</sup>	≤ 3 ≤ 3 ≤ 3	C3225X5R0J226KT/MT GRM32ER61J223M C1210C226K9PAC
TDK Ceramic X5R Murata Ceramic X5R Kemet	6.3 6.3 6.3	47 47 47	0.002 0.002 0.002	>1400 >1000 >1000	1210 case 3225 mm	≥ 1 ≥ 1 ≥ 1	≤ 3 ≤ 3 ≤ 3	C3225X5R0J476KT/MT GRM32ER60J476M/6.3 C1210C476K9PAC

- (1) A ceramic capacitor is required on both the input and the output. An electrolytic capacitor can be added to the output for improved transient response.
- (2) An optional through-hole capacitor available.
- (3) A total capacitance of 44 μF is an acceptable replacement for a single 47-μF capacitor.

## Power-Up Characteristics

When configured per the standard application, the PTH04070W power module produces a regulated output voltage following the application of a valid input source voltage. During power up, internal soft-start circuitry slows the rate that the output voltage rises, thereby limiting the amount of in-rush current that can be drawn from the input source. The soft-start circuitry introduces a short time delay (typically 10 ms) into the power-up characteristic. This is from the point that a valid input source is recognized. Figure 10 shows the power-up waveforms for a PTH04070W, operating from a 3-V input and with the output voltage adjusted to 1.8 V. The waveforms were measured with a 2-A resistive load.

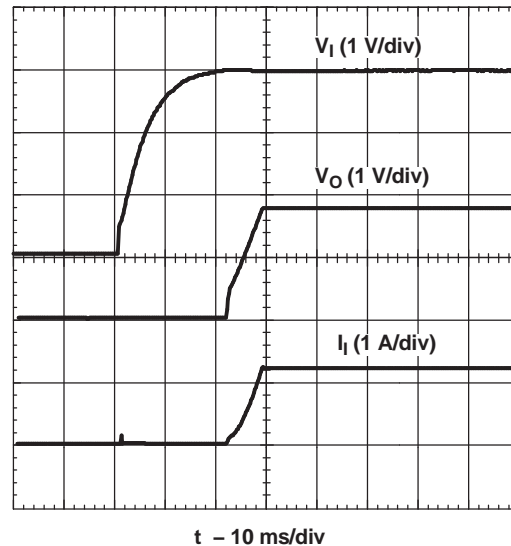

**Figure 10. Power-Up Waveforms**

## Current Limit Protection

The PTH04070W modules protect against load faults with a continuous current limit characteristic. Under a load fault condition, the output current cannot exceed the current limit value. Attempting to draw current that exceeds the current limit value causes the output voltage to be progressively reduced. Current is continuously supplied to the fault until it is removed. Upon removal of the fault, the output voltage will promptly recover.

## Thermal Shutdown

Thermal shutdown protects the module internal circuitry against excessively high temperatures. A rise in temperature may be the result of a drop in airflow, a high ambient temperature, or a sustained current limit condition. If the junction temperature of the internal components exceeds 150°C, the module shuts down. This reduces the output voltage to zero. The module will start up automatically, by initiating a soft-start power up when the sensed temperature decreases 10°C below the thermal shutdown trip point.

### Output On/Off Inhibit

For applications requiring output voltage on/off control, the PTH04070W power module incorporates an output on/off Inhibit control (pin 5). The inhibit feature can be used wherever there is a requirement for the output voltage from the regulator to be turned off.

The power module functions normally when the Inhibit pin is left open-circuit, providing a regulated output whenever a valid source voltage is connected to  $V_{in}$  with respect to GND.

Figure 11 shows the typical application of the inhibit function. Note the discrete transistor (Q1). The Inhibit control has its own internal pullup to  $V_I$  potential. An open-collector or open-drain device is recommended to control this input.

Turning Q1 on applies a low voltage to the *Inhibit* control pin and disables the output of the module. If Q1 is then turned off, the module will execute a soft-start power-up sequence. A regulated output voltage is produced within 20 msec. Figure 12 shows the typical rise in the output voltage, following the turn off of Q1. The turn off of Q1 corresponds to the fall in the waveform, Q1  $V_{gs}$ . The waveforms were measured with a 2-A resistive load.

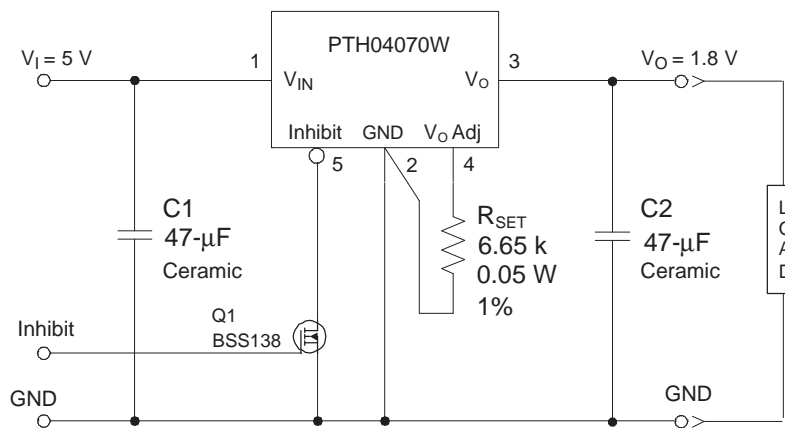

Figure 11. On/Off Inhibit Control Circuit

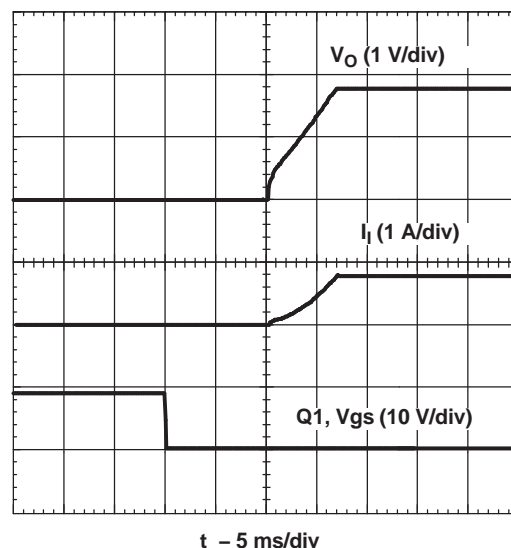

Figure 12. Power Up Response From Inhibit Control

**PACKAGING INFORMATION**

Orderable Device	Status (1)	Package Type	Package Drawing	Pins	Package Qty	Eco Plan (2)	Lead/Ball Finish (6)	MSL Peak Temp (3)	Op Temp (°C)	Device Marking (4/5)	Samples
PTH04070WAD	ACTIVE	Through-Hole Module	EVD	5	90	RoHS Exempt & Green	SN	N / A for Pkg Type	-40 to 85		<a href="#">Samples</a>
PTH04070WAH	ACTIVE	Through-Hole Module	EVD	5	90	RoHS Exempt & Green	SN	N / A for Pkg Type	-40 to 85		<a href="#">Samples</a>
PTH04070WAS	ACTIVE	Surface Mount Module	EVE	5	90	Non-RoHS & Green	SNPB	Level-1-235C-UNLIM/ Level-3-260C-168HRS	-40 to 85		<a href="#">Samples</a>
PTH04070WAST	ACTIVE	Surface Mount Module	EVE	5	250	Non-RoHS & Green	SNPB	Level-1-235C-UNLIM/ Level-3-260C-168HRS	-40 to 85		<a href="#">Samples</a>
PTH04070WAZ	ACTIVE	Surface Mount Module	EVE	5	90	RoHS Exempt & Green	SNAGCU	Level-3-260C-168 HR	-40 to 85		<a href="#">Samples</a>
PTH04070WAZT	ACTIVE	Surface Mount Module	EVE	5	250	RoHS Exempt & Green	SNAGCU	Level-3-260C-168 HR	-40 to 85		<a href="#">Samples</a>

(1) The marketing status values are defined as follows:

**ACTIVE:** Product device recommended for new designs.

**LIFEBUY:** TI has announced that the device will be discontinued, and a lifetime-buy period is in effect.

**NRND:** Not recommended for new designs. Device is in production to support existing customers, but TI does not recommend using this part in a new design.

**PREVIEW:** Device has been announced but is not in production. Samples may or may not be available.

**OBSOLETE:** TI has discontinued the production of the device.

(2) **RoHS:** TI defines "RoHS" to mean semiconductor products that are compliant with the current EU RoHS requirements for all 10 RoHS substances, including the requirement that RoHS substance do not exceed 0.1% by weight in homogeneous materials. Where designed to be soldered at high temperatures, "RoHS" products are suitable for use in specified lead-free processes. TI may reference these types of products as "Pb-Free".

**RoHS Exempt:** TI defines "RoHS Exempt" to mean products that contain lead but are compliant with EU RoHS pursuant to a specific EU RoHS exemption.

**Green:** TI defines "Green" to mean the content of Chlorine (Cl) and Bromine (Br) based flame retardants meet JS709B low halogen requirements of <=1000ppm threshold. Antimony trioxide based flame retardants must also meet the <=1000ppm threshold requirement.

(3) MSL, Peak Temp. - The Moisture Sensitivity Level rating according to the JEDEC industry standard classifications, and peak solder temperature.

(4) There may be additional marking, which relates to the logo, the lot trace code information, or the environmental category on the device.

(5) Multiple Device Markings will be inside parentheses. Only one Device Marking contained in parentheses and separated by a "~" will appear on a device. If a line is indented then it is a continuation of the previous line and the two combined represent the entire Device Marking for that device.

<sup>(6)</sup> Lead/Ball Finish - Orderable Devices may have multiple material finish options. Finish options are separated by a vertical ruled line. Lead/Ball Finish values may wrap to two lines if the finish value exceeds the maximum column width.

**Important Information and Disclaimer:**The information provided on this page represents TI's knowledge and belief as of the date that it is provided. TI bases its knowledge and belief on information provided by third parties, and makes no representation or warranty as to the accuracy of such information. Efforts are underway to better integrate information from third parties. TI has taken and continues to take reasonable steps to provide representative and accurate information but may not have conducted destructive testing or chemical analysis on incoming materials and chemicals. TI and TI suppliers consider certain information to be proprietary, and thus CAS numbers and other limited information may not be available for release.

In no event shall TI's liability arising out of such information exceed the total purchase price of the TI part(s) at issue in this document sold by TI to Customer on an annual basis.

EVE (R-PDSS-T5)

DOUBLE SIDED MODULE

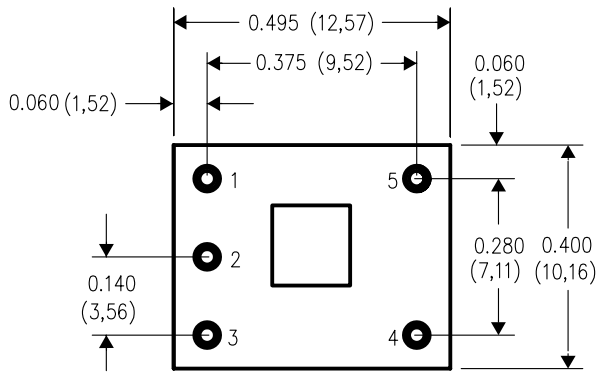

TOP VIEW

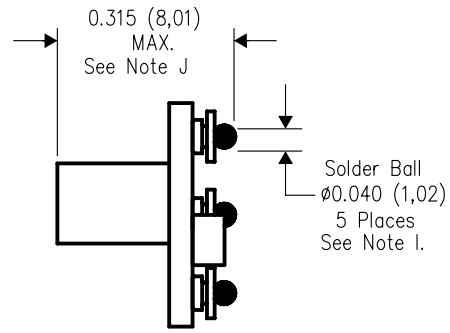

SIDE VIEW

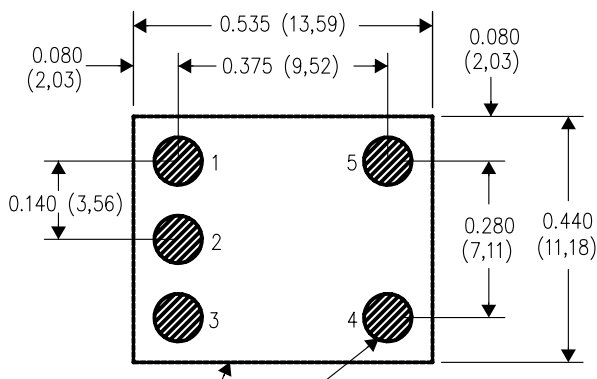

PC LAYOUT

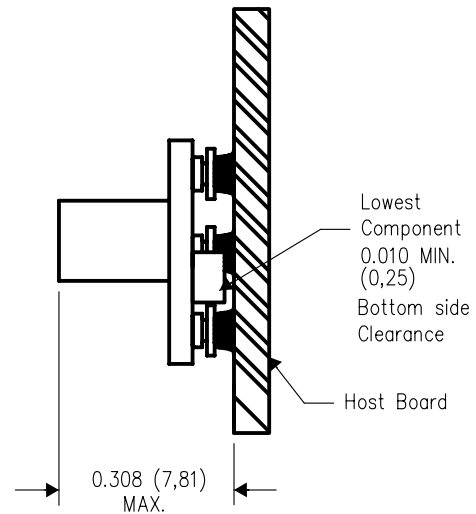

4206289/A 08/04

- NOTES:
- A. All linear dimensions are in inches (mm).
  - B. This drawing is subject to change without notice.
  - C. 2 place decimals are  $\pm 0.030$  ( $\pm 0,76$ mm).
  - D. 3 place decimals are  $\pm 0.010$  ( $\pm 0,25$ mm).
  - E. Recommended keep out area for user components.
  - F. Power pin connection should utilize two or more vias to the interior power plane of 0.025 (0,63) I.D. per input, ground and output pin (or the electrical equivalent).

- G. Paste screen opening: 0.080 (2,03) to 0.085 (2,16).  
Paste screen thickness: 0.006 (0,15).
- H. Pad type: Solder mask defined.
- I. All pins: Material - Copper Alloy  
Finish - Tin (100%) over Nickel plate  
Solder Ball - See product data sheet.
- J. Dimension prior to reflow solder.

EVD (R-PDSS-T5)

DOUBLE SIDED MODULE

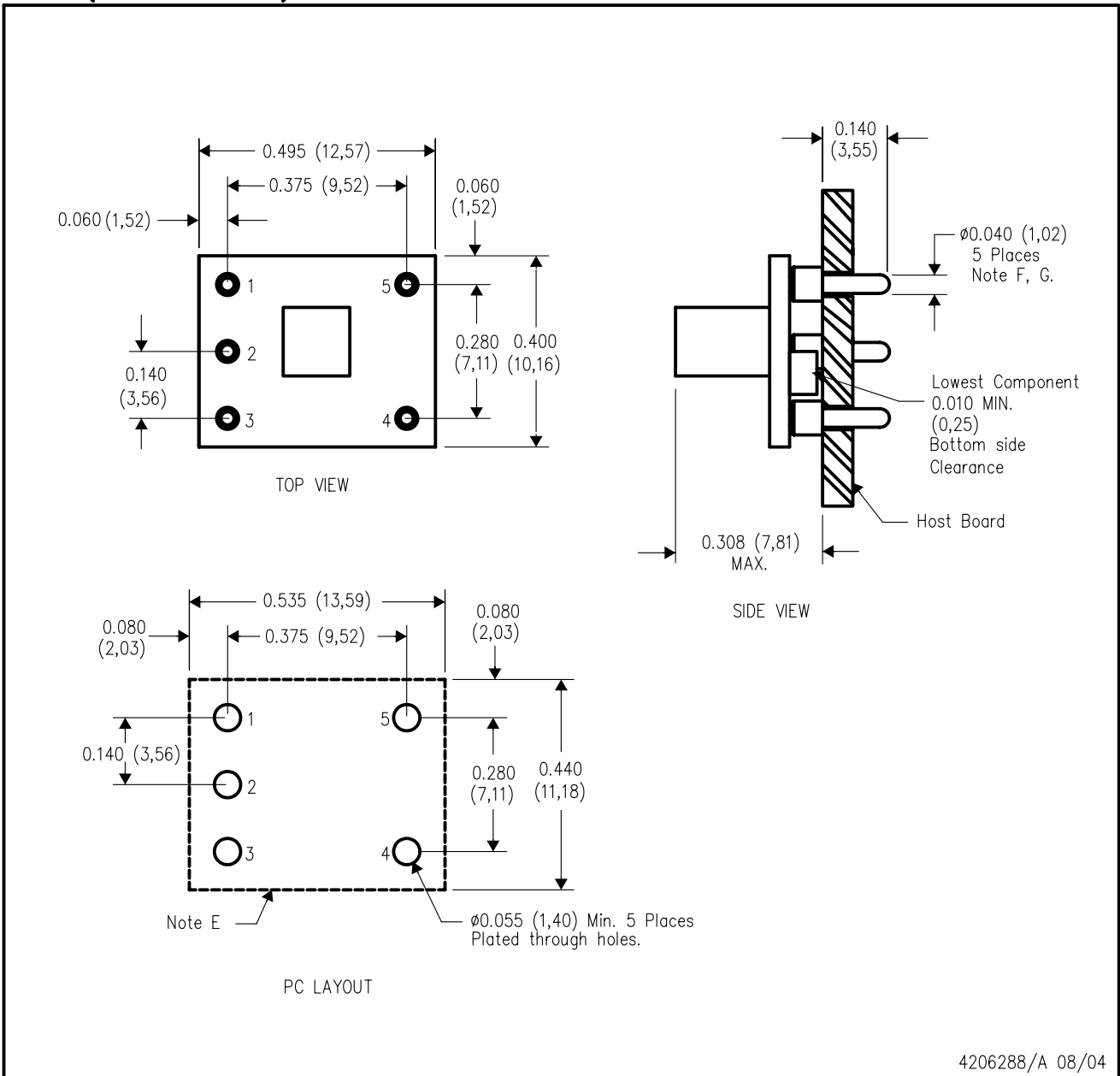

4206288/A 08/04

- NOTES:
- A. All linear dimensions are in inches (mm).
  - B. This drawing is subject to change without notice.
  - C. 2 place decimals are  $\pm 0.030$  ( $\pm 0,76$ mm).
  - D. 3 place decimals are  $\pm 0.010$  ( $\pm 0,25$ mm).
  - E. Recommended keep out area for user components.

- F. Pins are 0.040" (1,02) diameter with 0.070" (1,78) diameter standoff shoulder.
- G. All pins: Material - Copper Alloy  
Finish - Tin (100%) over Nickel plate



## IMPORTANT NOTICE AND DISCLAIMER

TI PROVIDES TECHNICAL AND RELIABILITY DATA (INCLUDING DATASHEETS), DESIGN RESOURCES (INCLUDING REFERENCE DESIGNS), APPLICATION OR OTHER DESIGN ADVICE, WEB TOOLS, SAFETY INFORMATION, AND OTHER RESOURCES "AS IS" AND WITH ALL FAULTS, AND DISCLAIMS ALL WARRANTIES, EXPRESS AND IMPLIED, INCLUDING WITHOUT LIMITATION ANY IMPLIED WARRANTIES OF MERCHANTABILITY, FITNESS FOR A PARTICULAR PURPOSE OR NON-INFRINGEMENT OF THIRD PARTY INTELLECTUAL PROPERTY RIGHTS.

These resources are intended for skilled developers designing with TI products. You are solely responsible for (1) selecting the appropriate TI products for your application, (2) designing, validating and testing your application, and (3) ensuring your application meets applicable standards, and any other safety, security, or other requirements. These resources are subject to change without notice. TI grants you permission to use these resources only for development of an application that uses the TI products described in the resource. Other reproduction and display of these resources is prohibited. No license is granted to any other TI intellectual property right or to any third party intellectual property right. TI disclaims responsibility for, and you will fully indemnify TI and its representatives against, any claims, damages, costs, losses, and liabilities arising out of your use of these resources.

TI's products are provided subject to TI's Terms of Sale ([www.ti.com/legal/termsofsale.html](http://www.ti.com/legal/termsofsale.html)) or other applicable terms available either on [ti.com](http://ti.com) or provided in conjunction with such TI products. TI's provision of these resources does not expand or otherwise alter TI's applicable warranties or warranty disclaimers for TI products.

Mailing Address: Texas Instruments, Post Office Box 655303, Dallas, Texas 75265  
Copyright © 2020, Texas Instruments Incorporated